

Nanodyne Replacement Illuminator for Olympus BH Microscope Installation Instructions - Included Items

Additional Items Included But Not Shown:
 PN 10457 Hex Key 2.5mm (for M3 mounting screws)

Not Included:
 Intensity Adjust Knob - Save From Old Slide Pot

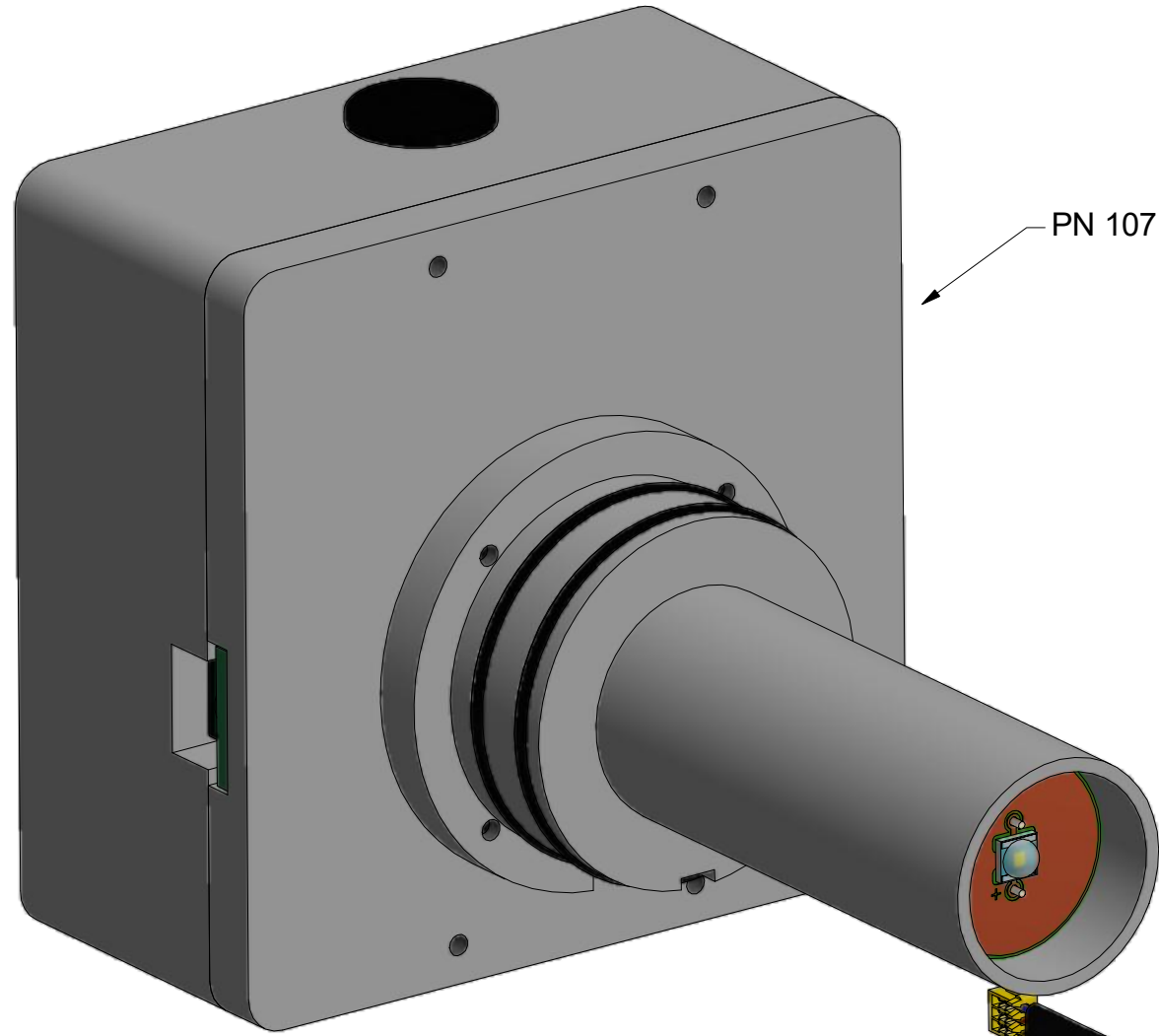

PN 10715 Olympus BH Illuminator Assy

PN 10272 Slide Pot Assy

PN 11002 Pot Cable Assy



PN 10733 Power Supply - XP Power 5V 1A Fixed Blade US Input/USB Output and PN 10734 Cable Assy 1.35mm ID x 3.5mm OD RA plug to USB A, 6 foot.

The illuminator may be powered by plugging the cable into the power supply provided, or into a suitable USB port on a computer or other device.

Power supplies are subject to substitution without notice due to availability issues and changes in regulations.

Wayne Bonin	2/20/2019
PN 10716 Olympus BH Installation Instructions	REV 3
SHEET 1 OF 7	

Nanodyne Replacement Illuminator for Olympus BH Microscope Installation Instructions - Step 1. Remove old illuminator, bottom cover and intensity control knob.

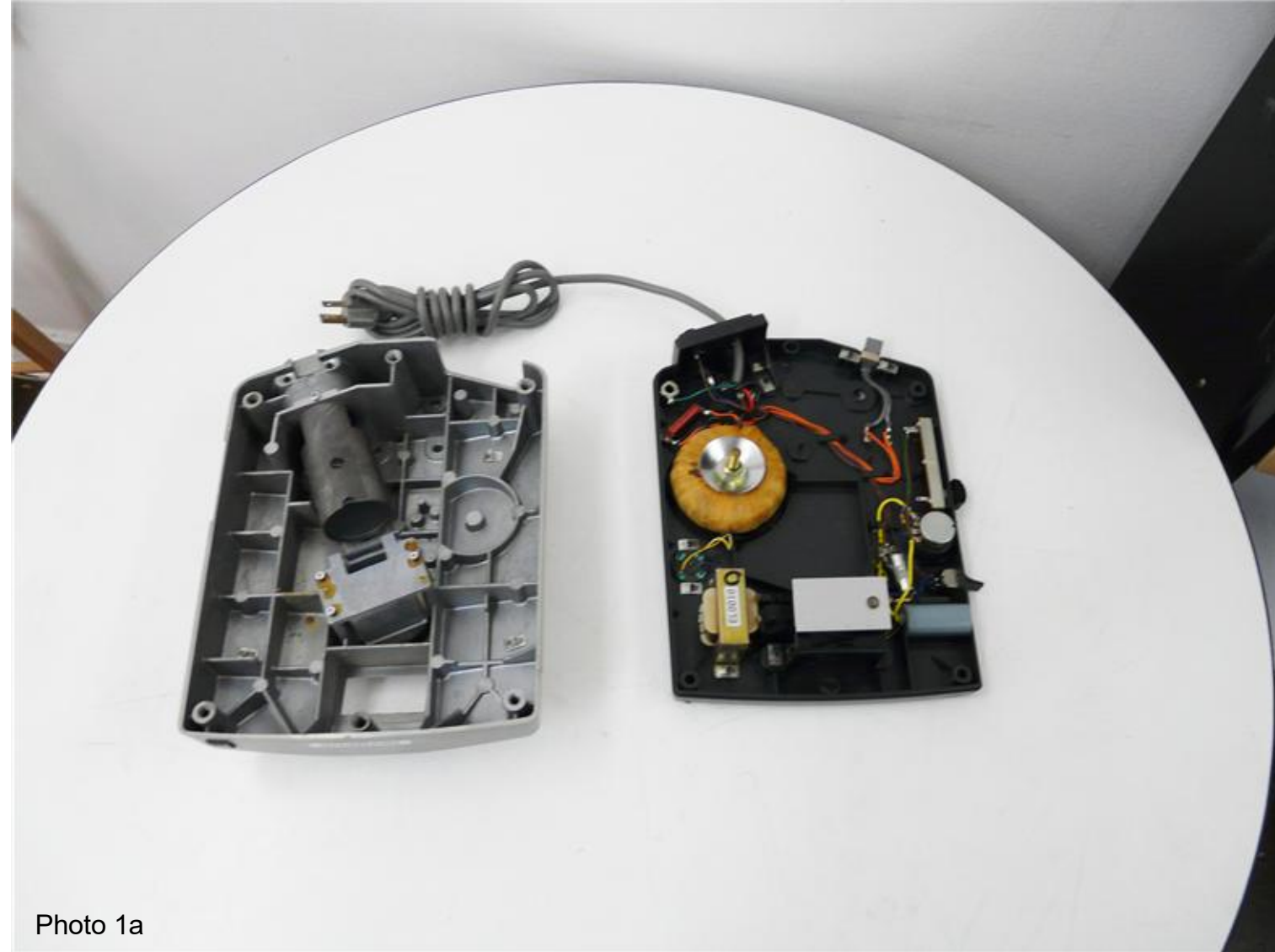

Photo 1a

Remove the old illuminator from the back of the microscope and discard it. Then remove the bottom cover of the microscope by removing the four screws located in the feet. **NOTE: Only a microscope base is pictured in this installation. The base does not need to be removed from the rest of the microscope.**



Photo 1b

Remove the two screws that hold the slider potentiometer in place. These screws can be discarded. Also remove the knob from the old potentiometer by pulling it free, keeping it for later in the installation.

Wayne Bonin	2/20/2019
PN 10716 Olympus BH Installation Instructions	REV 3
SHEET 2	OF 7

Nanodyne Replacement Illuminator for Olympus BH Microscope Installation Instructions - Step 2. Cut and remove old wires.

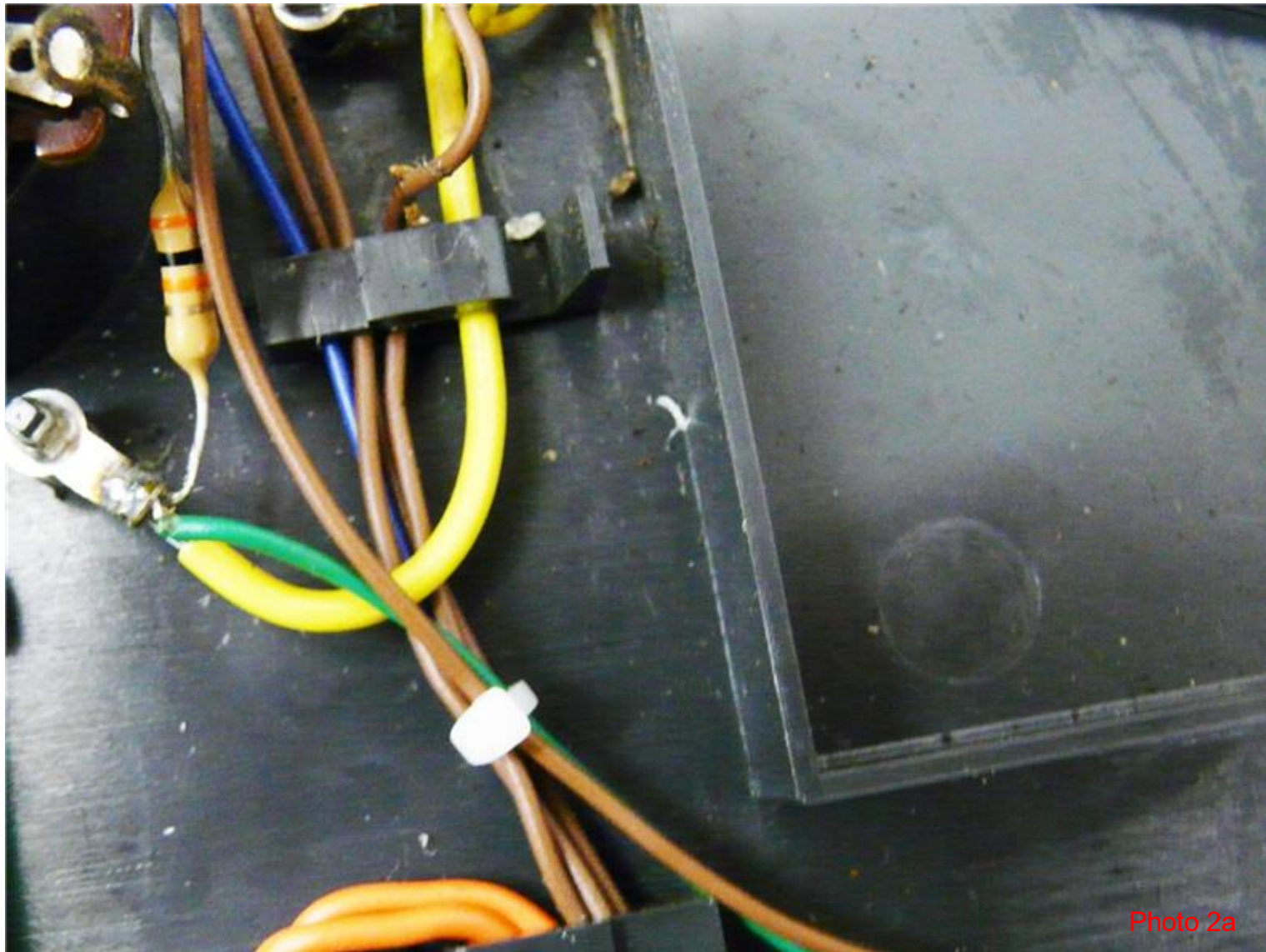

Photo 2a

Cut the connections at the old potentiometer and discard the old potentiometer. Tie any loose connections down with one of the cable ties provided.

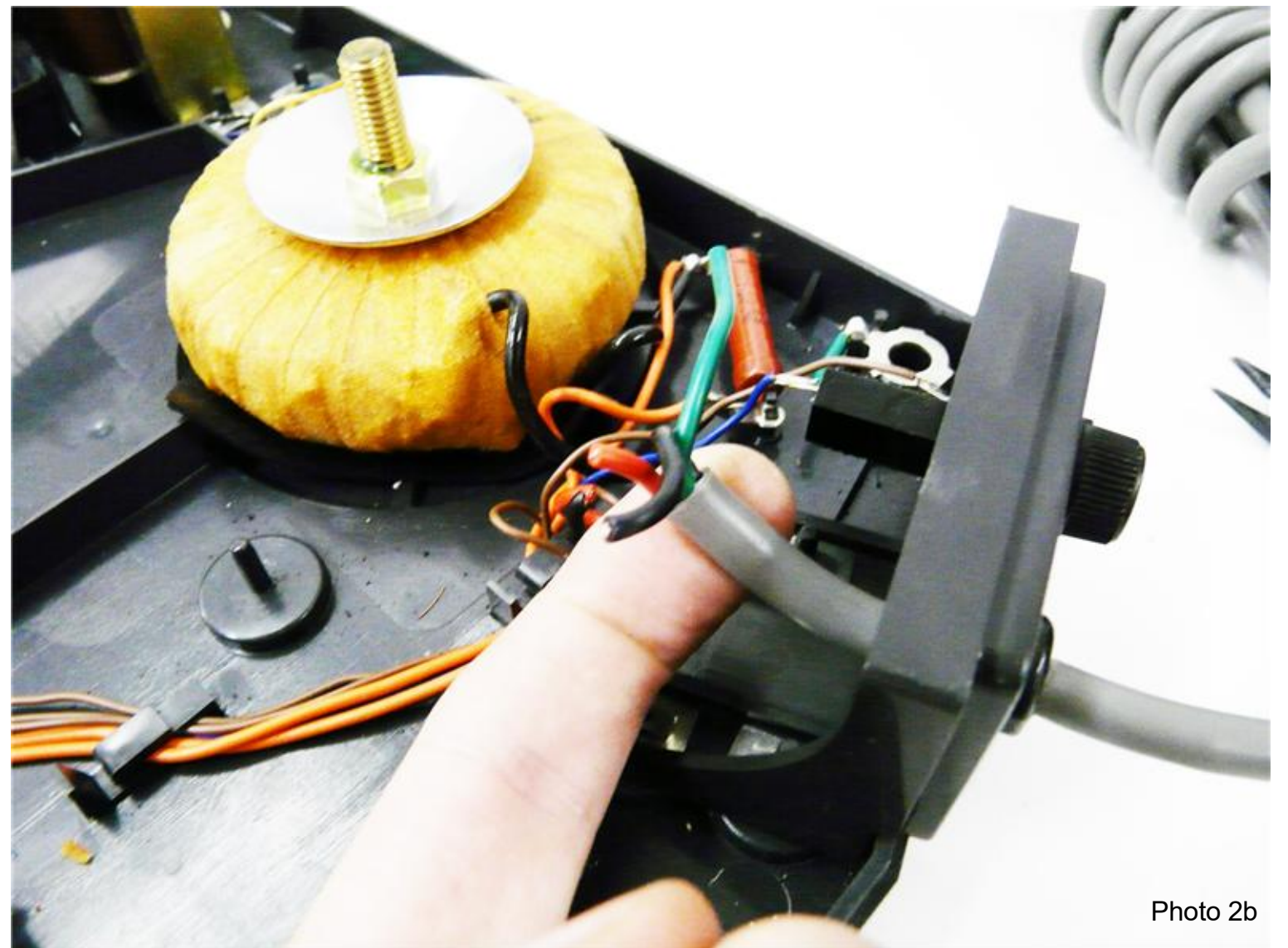

Photo 2b

Cut the connections going to the AC power line. The new illuminator system runs on its own DC power supply, so the AC connections are no longer needed. In addition, removing the AC power lines is a safety measure to avoid electrical shock if the microscope was plugged in by mistake while being maintained.

Wayne Bonin	2/20/2019
PN 10716 Olympus BH Installation Instructions	REV 3
SHEET 3 OF 7	

Nanodyne Replacement Illuminator for Olympus BH Microscope Installation Instructions - Step 3. Cut and remove AC power cord.



Photo 3a

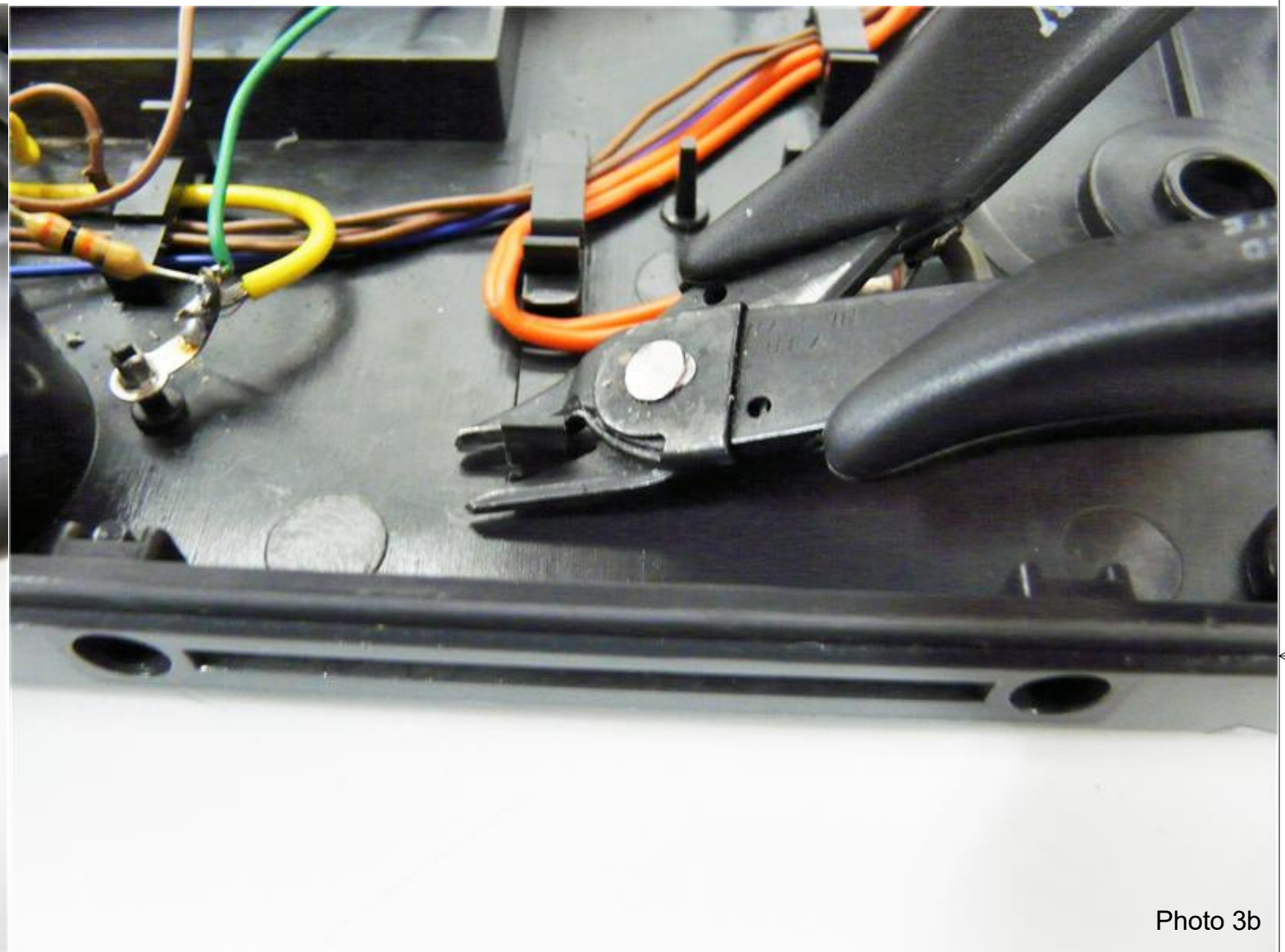

Photo 3b

Using a pliers or similar tool, squeeze the connector holding the AC power line in place. Once squeezed, pull the connector from the back of the microscope. The AC power cord can be discarded.

Cut the potentiometer alignment tab in order to make room for the new potentiometer, as shown above.

Wayne Bonin	2/20/2019
PN 10716 Olympus BH Installation Instructions	REV 3
SHEET 4	OF 7

Nanodyne Replacement Illuminator for Olympus BH Microscope Installation Instructions - Step 4. Install new potentiometer.

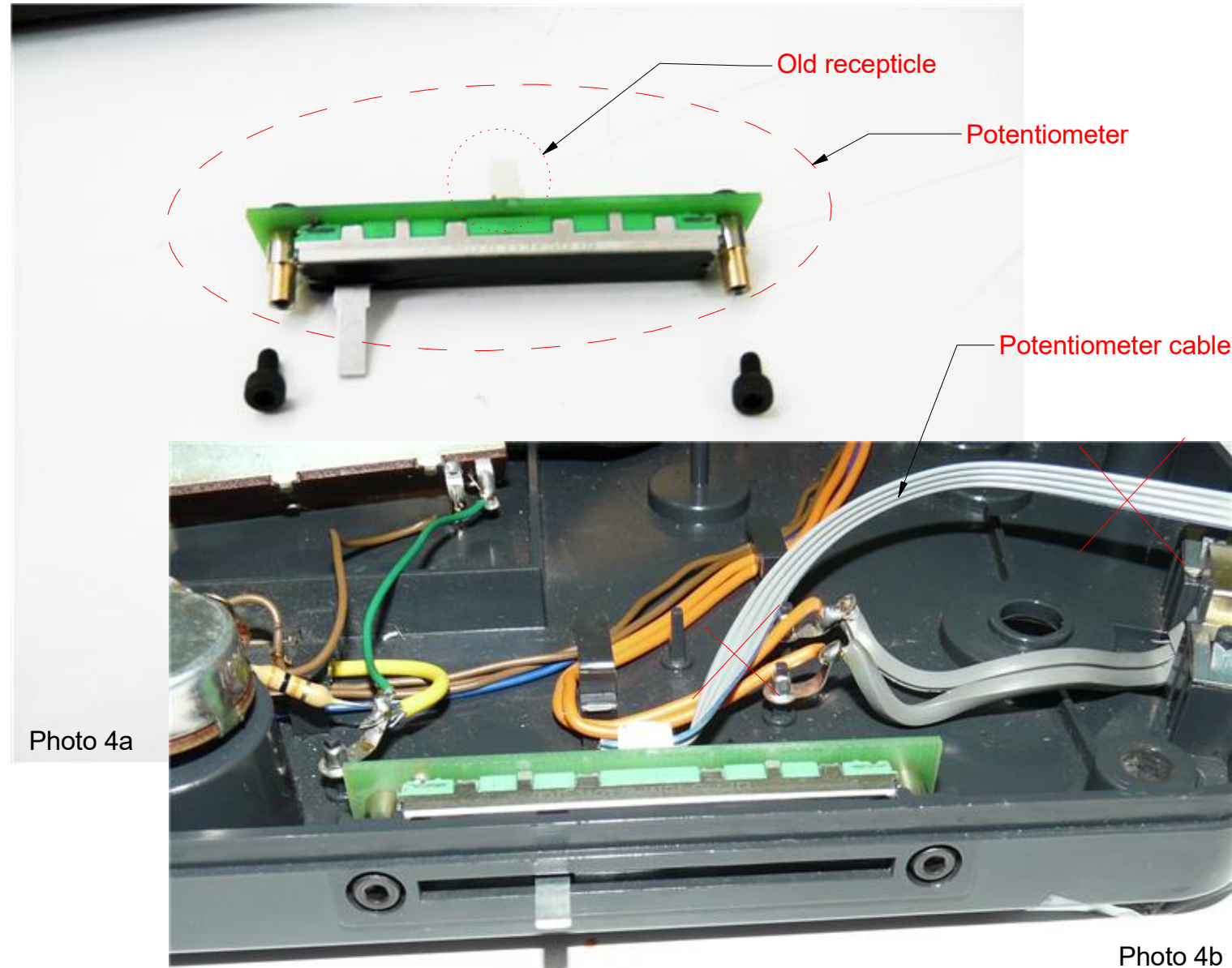

Tie the ribbon cable down to the existing cabling using one of the cable ties provided. This ensures that the ribbon cable will not interfere with any existing microscope components.

Remove the two screws from the standoffs, as shown in the top picture above. Position the new potentiometer in place, and install the two screws into place using the hex key provided. **NOTE: Be sure that the side of the circuit board that says "MIN" will match up with the minimum brightness printing on the bottom casing of the microscope. In the picture above, the "MIN" printing is on the left.** Replace the potentiometer knob onto the new potentiometer. **NOTE: Do not insert the potentiometer knob onto the potentiometer too far or it will interfere against the casing when it is re-installed, and won't slide smoothly.**

* Note: Potentiometer (PN 10272, red circle) and potentiometer cable (PN 10962, red X) in this page are outdated. It is currently replaced to revised ones (PN 10272 R2 and PN 11002, respectively as shown in the first page).

Wayne Bonin	2/20/2019
PN 10716 Olympus BH Installation Instructions	REV 3
SHEET 5 OF 7	

Nanodyne Replacement Illuminator for Olympus BH Microscope Installation Instructions - Step 5. Connect the Pot Cable to the Illuminator.

Connect the plug at the end of the Pot Cable Assembly to the mating socket of the illuminator, as shown in the pictures on this page. NOTE THAT THE PLUG IS KEYED TO ONLY GO INTO THE SOCKET ONE WAY, AS SHOWN.

Partially insert the plug into the mating socket of the illuminator by holding the wire next to the plug with your finger (photo 2).

Use your fingernails, if you have them, or tools like a tiny screwdriver or tweezers pushing on the side of the plug to fully insert it (photo 3).

The socket cannot be fully engaged by pushing on the wires, as the wires would just collapse.

To disconnect it if needed, pull the wire straight out by firmly gripping the black heat shrink tubing.

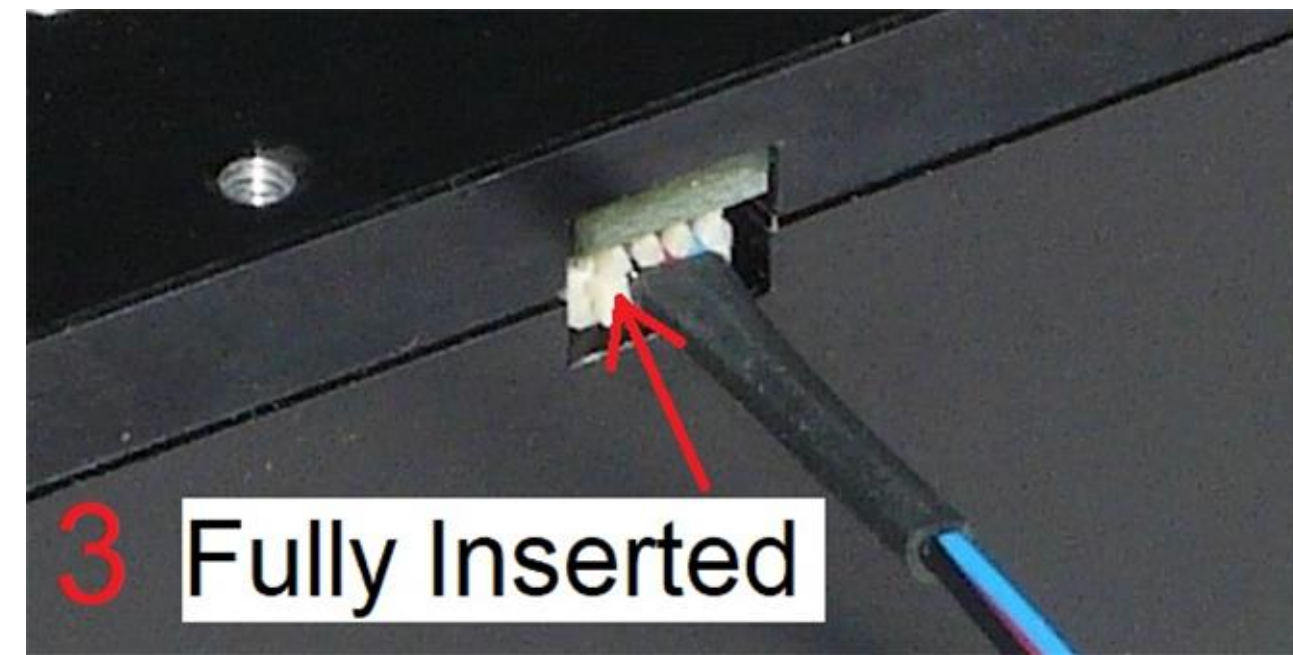
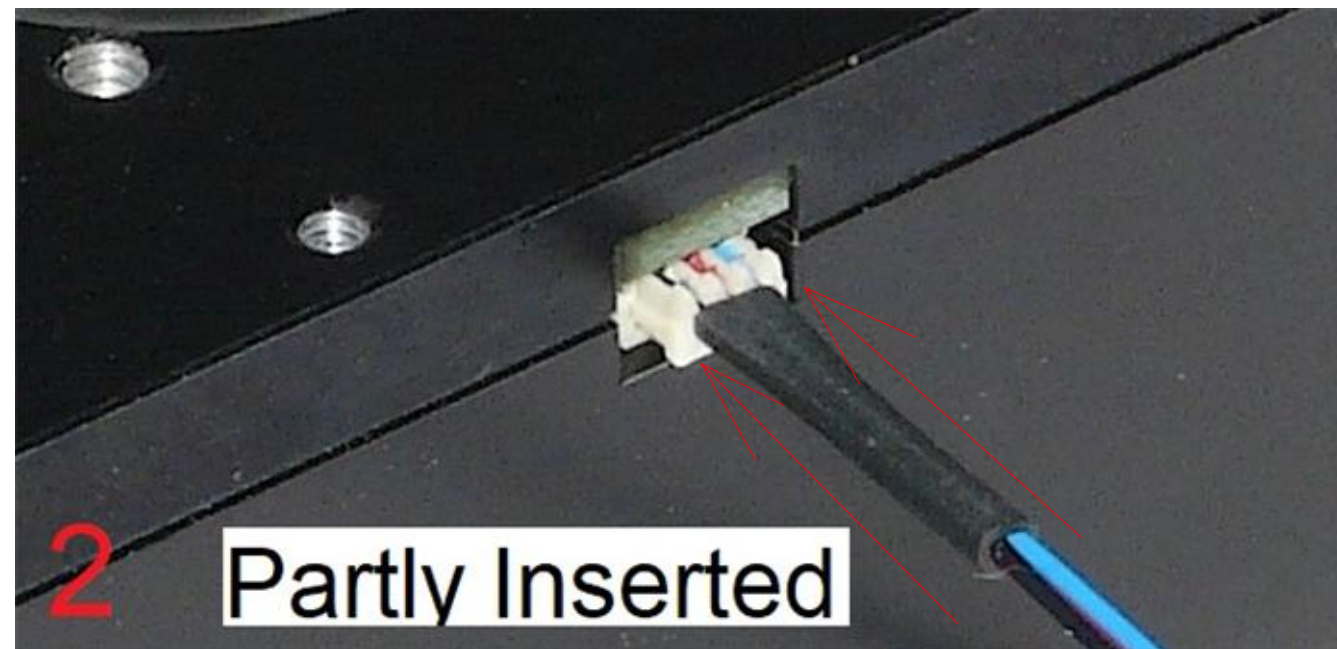
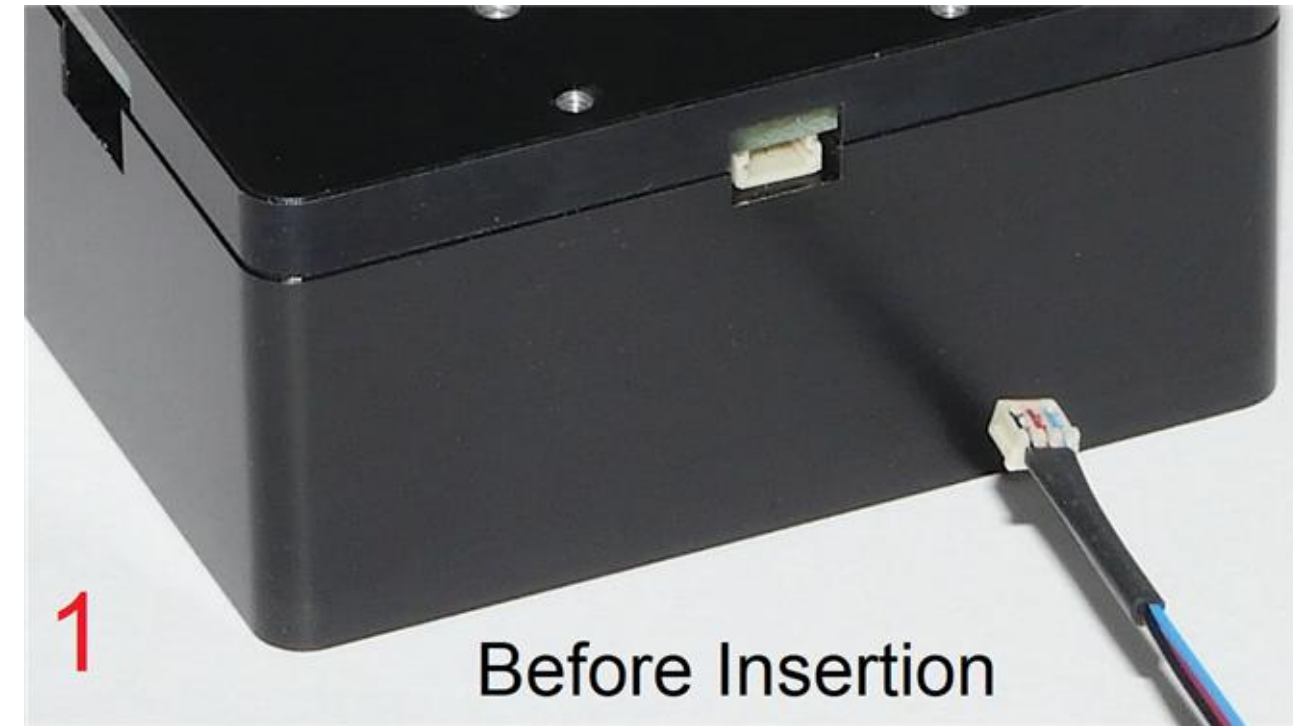

Wayne Bonin	2/20/2019
PN 10716 Olympus BH Installation Instructions	REV 3
SHEET 6	OF 7

Nanodyne Replacement Illuminator for Olympus BH Microscope Installation Instructions - Step 6. Plug in and install Nanodyne illuminator.

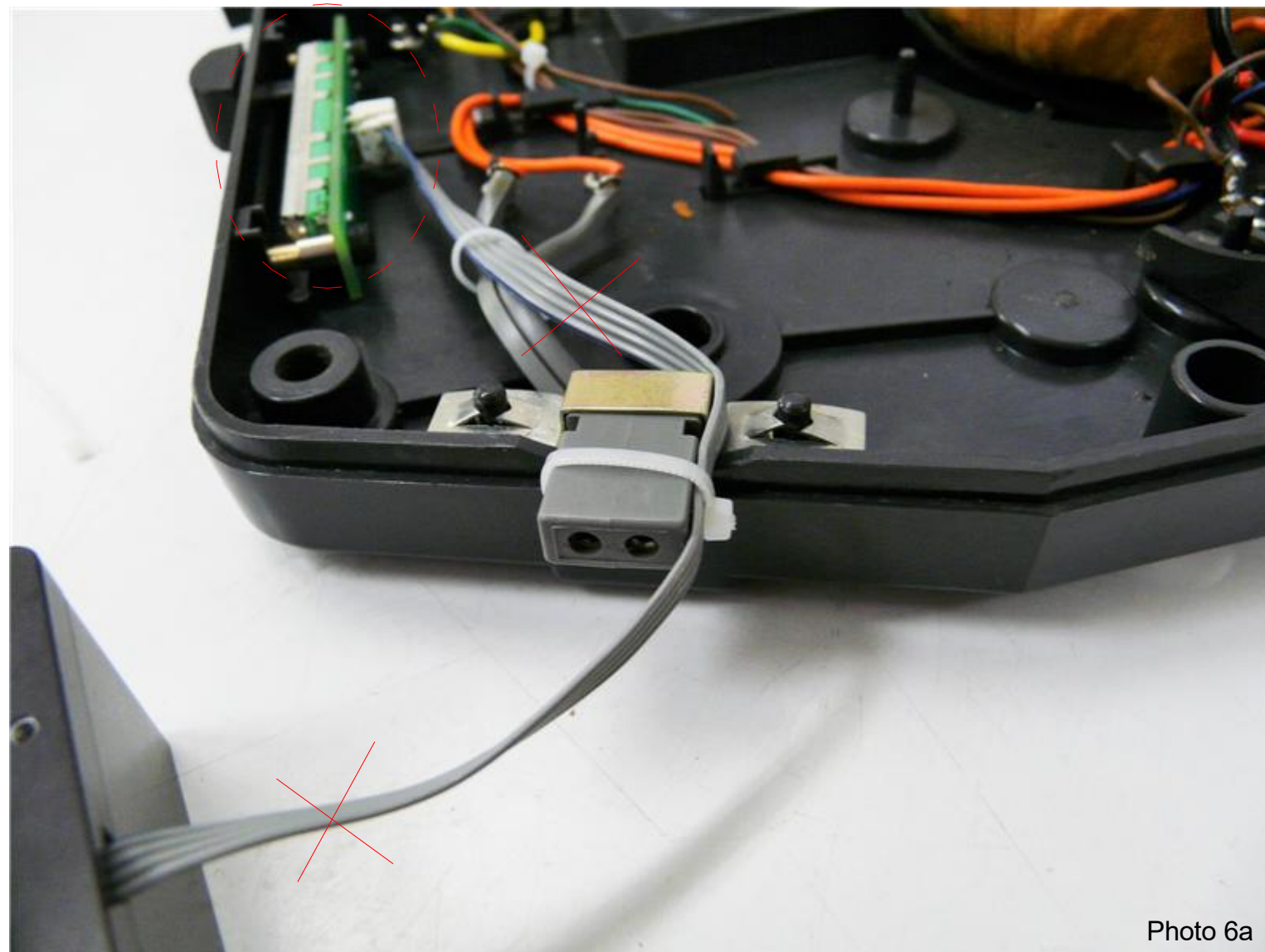

Photo 6a



Photo 6b

Plug in the potentiometer cable onto the bottom of the illuminator (details were described in page 6) and route any slack cable back into the microscope. Tie the ribbon cable to the old power connector using one of the cable ties provided. This ensures that when the case is placed on top of the base, the ribbon cable does not get crushed or severed.

Replace the casing onto the base. Insert the new illuminator into the lighting hole, ensuring that it is pushed in all the way. Replace the screws that hold the microscope base in place. Plug in the new illuminator and it is ready for use.

* Note: Left image for potentiometer (PN 10272, red circle) and potentiometer cable (PN 10962, red X) are outdated. It is currently replaced to revised ones (PN 10272 R2 and PN 11002, respectively as shown on the first page).

Wayne Bonin	2/20/2019
PN 10716 Olympus BH Installation Instructions	REV 3
SHEET 7 OF 7	